

# electriciQ

## USER MANUAL

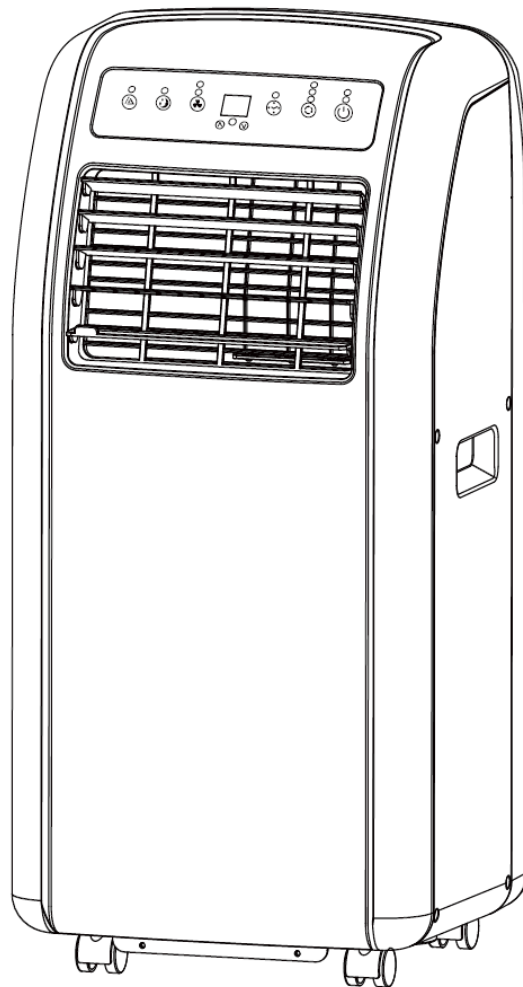

### **SILENT10** **PORTABLE AIR CONDITIONER**

Thank you for choosing electriciQ  
Please read this user manual before using this innovative Air Conditioner and keep it  
safe for future reference.

Visit our page [www.electriQ.co.uk](http://www.electriQ.co.uk) for our entire range of Intelligent Electricals

# CONTENTS

<b>SAFETY INSTRUCTIONS</b> .....	<b>3</b>
<b>OPERATION</b> .....	<b>8</b>
<b>REMOTE CONTROL</b> .....	<b>9</b>
<b>EMPTYING THE INTERNAL WATER TANK</b> .....	<b>10</b>
<b>MANUAL DRAINAGE:</b> .....	<b>10</b>
<b>MAINTENANCE</b> .....	<b>11</b>
<b>CLEANING</b> .....	<b>11</b>
<b>END OF SEASON MAINTENANCE</b> .....	<b>11</b>
<b>TROUBLESHOOTING.</b> .....	<b>12</b>
<b>APPENDIX</b> .....	<b>13</b>
<b>TECHNICAL DATA</b> .....	<b>13</b>

# SAFETY INSTRUCTIONS



## Important!

- Carefully read the instructions before operating the unit
- This appliance is for indoor use only.
- Rating: This unit must be only connected to a 220-240 V / 50 Hz earthed outlet.
- Installation must be in accordance with regulations of the country where the unit is used.
- If you are in any doubt about the suitability of your electrical supply have it checked and, if necessary, modified by a qualified electrician.
- This air conditioner has been tested and is safe to use. However, as with any electrical appliance - use it with care.
- Disconnect the power from the appliance before dismantling, assembling or cleaning.
- Avoid touching any moving parts of the appliance.
- Never insert fingers, pencils or any other objects through the guard
- This appliance is not intended for use by persons (including children) with reduced physical, sensory or mental capabilities. It is also not intended for use by those with a lack of experience and knowledge, unless they have been given supervision or instruction concerning the use of the appliance by a person responsible for their safety.
- Do not leave children unsupervised with this appliance.
- Do not clean the unit by spraying it or immersing it in water.
- Never connect the unit to an electrical outlet using an extension cord. If an outlet is not available, one should be installed by a qualified electrician.
- Never operate this appliance if the cord or plug is damaged. Ensure the power cord is not stretched or exposed to sharp objects/edges.
- A damaged supply cord should be replaced by the manufacturer or a qualified electrician in order to avoid a hazard.
- Any service other than regular cleaning or filter replacement should be performed by an authorised service representative. Failure to comply could result in a voided warranty.
- Do not use the appliance for any other purposes than its intended use.
- **The air conditioner unit must always be stored and transported upright, otherwise irreparable damage may be caused to the compressor; if in doubt we suggest waiting at least 24 hours before starting the unit.**
- Avoid restarting the air conditioning unit unless 3 minutes have passed since being turned off. This prevents damage to the compressor.
- Never use the mains plug as a switch to start and turn off the air conditioning unit. Use the provided ON/OFF switch located on the control panel.
- Always place the unit on a dry and stable surface.
- The appliance should not be installed in laundry or wet rooms.
- The appliance must be placed in a room without sources of ignition (for example: open flames, an operating gas appliance or an operating electric heater).



## R290

- R290 refrigerant gas complies with European environmental directives.
  - R290 has a low GWP (Global Warming Potential) of 3.
  - The air conditioner contains about 220 g of R290 refrigerant gas.
  - Do not use or store in an unventilated space with an area smaller than 10.5m<sup>2</sup> per unit. The room must be such as to prevent stagnation of possible leaks of refrigerant gas as there could be a danger of fire or explosion hazard should the refrigerant come into contact with electric heaters, stoves or other sources of ignition.
- If the appliance is installed, used or stored in an unventilated room, the room must be such as to prevent stagnation of possible leaks of refrigerant gas as there could be a danger of fire or explosion should the refrigerant come into contact with electric heaters, stoves or other sources of ignition.
  - Refrigerant gas may be odourless.
  - Do not use the product and contact the retailer for advice, if damage has occurred to the unit which may have compromised the refrigerant system.
  - Any repairs or maintenance must only be carried out on the unit by a suitably qualified engineer. Before opening and servicing the unit the authorized engineer must be in possession of a copy of the manufacturer's service manual and must follow the safety information contained within it to ensure all hazards are minimized.
  - The refrigerant system should not be perforated or punctured.

### **Energy Saving and Unit Safety Protection Tips**

- Do not cover or restrict the airflow from the outlet or inlet grills.
- For maximum performance the minimum distance from a wall or objects should be 50cm.
- Keep the filters clean. Under normal conditions, filters should only need cleaning once every three weeks (approximately). Since the filters remove airborne particles, more frequent cleaning maybe necessary, depending on the air quality.
- For the initial start up set the fan speed to maximum and the thermostat to 4-5 degrees lower than the current temperature. After, set the fan switch to low and set the thermostat to your desired setting.
- To protect the unit we recommend not using the cooling function when the ambient temperature is higher than 35°C.

# FEATURES AND PARTS LIST

## FEATURES

- Self-evaporative system - no external water tank needed
- Designer inspired luxury model
- Bright LED screen, indicates temperature and operation mode
- On/Off timer function – allows you to choose when the unit operates
- Compressor protection technology

## PARTS LIST

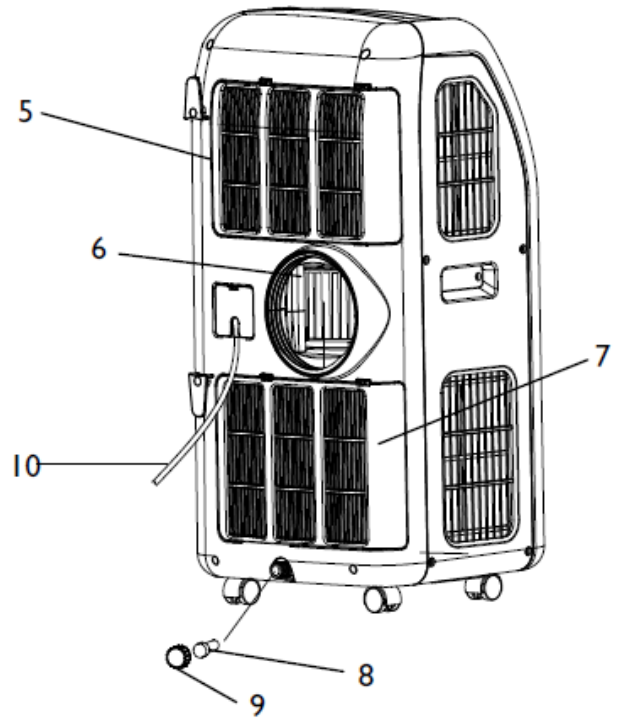
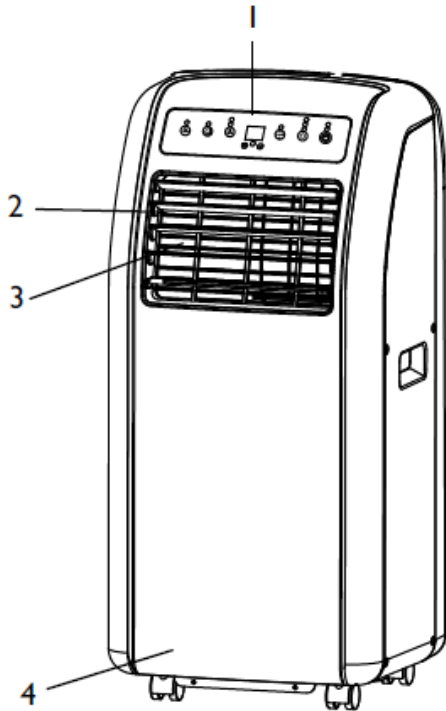

1. Control Panel
2. Air Outlet
3. Fan Blade
4. Castors
5. Upper Filter Frame

6. Exhaust Connector
7. Lower Filter Frame
8. Rubber Stopper
9. Drain Plug Cap
10. Power Cord

Accessories:

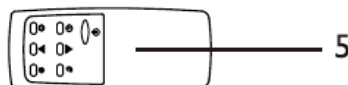
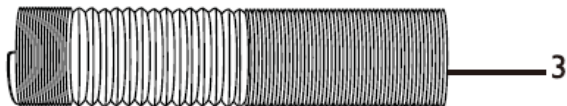
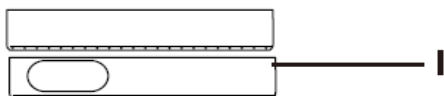

1. Extendable slide bar
2. Screw, Washer, Nut (for slide bar)
3. Extendable Exhaust Hose (upto 1.5m)
4. Fishtail adaptor
5. Remote control

## INSTALLATION

**Warning: Before using this unit, please keep it upright for at least 3-4 hours.**

This unit can easily be moved from one room to another.

While moving the unit please note that it must always be kept upright and then placed on an even surface.

1. Attach the fishtail connector to the end of the hose, by extending the end and twisting until firmly attached (At least 3 full rotations)

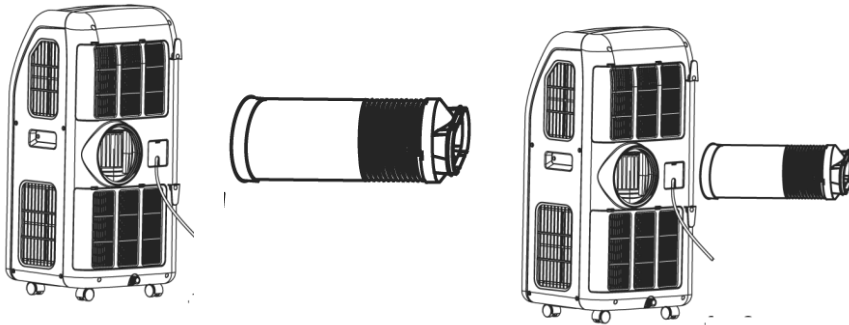
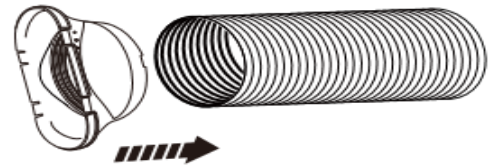

2. Extend the opposite end of the hose and screw into the exhaust connector on the rear of the air conditioner (At least 3 full turns)

3. Make sure the unit is upright and there are no obstructions to the air inlets and outlet grills.

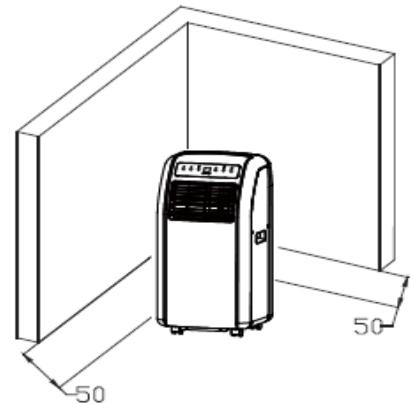

## INSTALLATION OF WINDOW KIT.

The window kit (slide bar and fishtail) can be used with sliding windows and doors. For other types of window, the fishtail should be used on its own.

1. Partially open the window and then fix the window kit to the window.

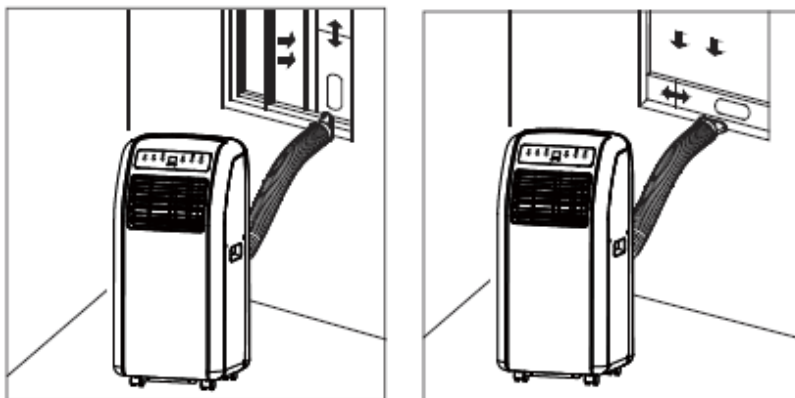
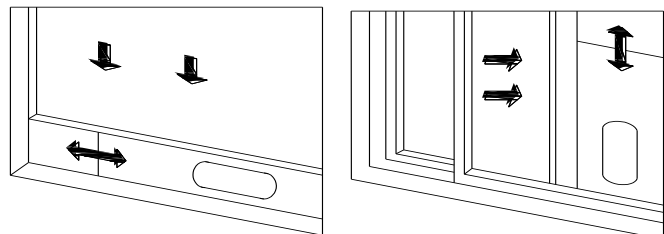

2. Fix the other end of the hose to the air-outlet window kit.

## NOTES:

- The window kit is only designed to be installed with sliding or sash windows or doors. The window kit is not designed or to be used with any other style of windows.
- The fish tail adaptor can be used without the slide bar with most windows / doors.
- When using the air conditioner ensure that the opening left around the fishtail is as small as possible as the cooling will be less efficient.
- The best form of installation is through a wall duct. By properly venting you expel hot air from your room while efficiently cooling it.
- Your air conditioner should be used without the vent pipe in dehumidifier mode. When using dehumidifier mode ensure that an external water tank is used, monitored and regularly emptied before overflowing. Permanent plumbing can be also installed for dehumidifier mode or an external uplift water pump can be set up for unattended use.

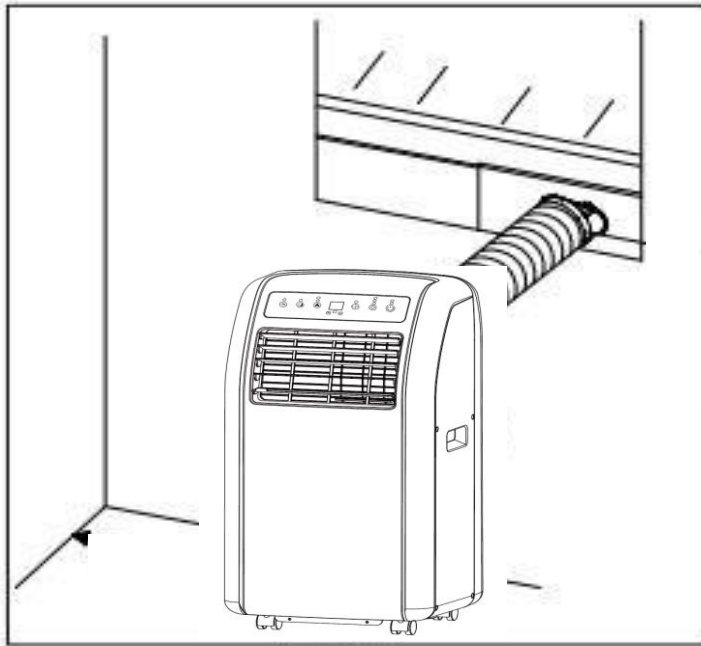

## IMPORTANT SAFEGUARDS

The length of the soft hose extends from 28 cm to 150 cm. If hose is extended above this length the unit may malfunction and this can invalidate the warranty. The outlet vent must be well ventilated and not obstructed as this will cause the unit to overheat. Avoid bending the air hose more than 30 degrees

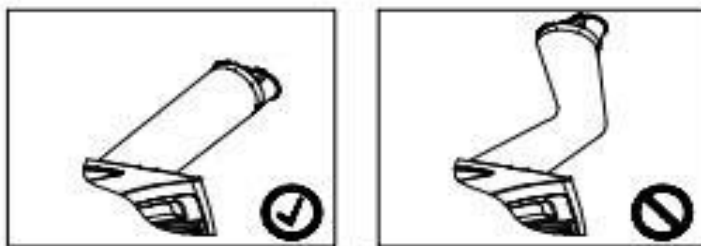

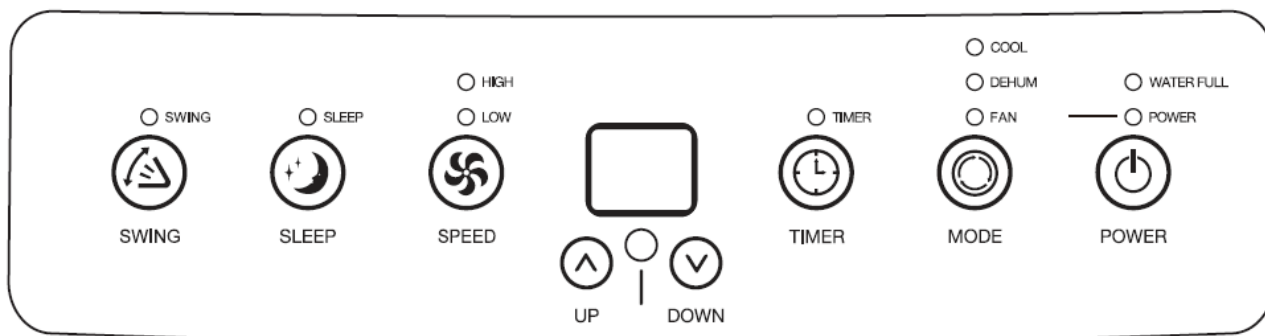

# OPERATION





When first plugged in the unit will automatically enter standby status.

**ON/OFF**  button: Press to turn the unit on and enter cooling mode. The unit will default to cooling mode with a desired temperature of 22°C. Press again and the unit will switch off.

**MODE BUTTON**  : Press this button to change between Cooling, Fan and Dehumidifying Modes.

**FAN BUTTON**  **FAN AND COOLING MODE:** Press to change between the available fan speeds.

HIGH (  ) → LOW (  )

**DEHUMIDIFYING MODE:** The fan is set to low speed and cannot be changed



**TIMER**  : Timer functions cannot be combined or repeated.

## POWER ON TIMER

With the appliance in standby, press the “TIMER” button to setup the power-on time. Press the UP and DOWN buttons to adjust the duration of the timer (from 1 to 24 hours). Timer indicator turns on. The unit will start after selected number of hours.

## POWER OFF TIMER

With the appliance running with the desired settings, press the “TIMER” button to setup the power-off timer. Press the UP and DOWN buttons to adjust the duration of the timer (from 1 to 24 hours). The timer indicator will illuminate. The unit will stop after selected number of hours.

**UP**  **AND DOWN**  **BUTTONS:** Press to adjust the desired temperature and timer. In cooling mode, the temperature can range from 16 - 31°C. Press the UP and DOWN buttons together to change between °C and °F.

**SLEEP MODE BUTTON**  :

While in cooling pressing the “SLEEP” button will put the unit in sleep mode.

The fan speed will change to low.

It will automatically increase the desired temperature by 1°C after an hour and by a further 1°C after a further hour. This means the unit will spend less time with the compressor running, and so run quieter.

The sleep function cannot be used in dehumidify and fan modes.









If the water tank is filled, the unit is put into standby or the mode is changed, sleep mode will be cancelled.

**SWING BUTTON**  : press this button to start the auto swing function (left to right on the inner louvres), press again to cancel. Stopping the swing will lock the louvres position.



## REMOTE CONTROL

The air conditioner can be controlled with the remote control. Two AAA-batteries are required to use the remote control.

1. **POWER** : Press the POWER button to turn the machine on or off.
2. **TIMER** : Press the TIMER button to set the timer.
3. **DOWN** : Press the DOWN button to decrease the desired temperature or timer
4. **MODE** : Press the MODE button to switch between cooling, fan and dehumidifier modes.
5. **UP** : Press the UP button to increase the desired temperature or timer
6. **FAN** : Press the FAN button to change between high and low fan speeds.
7. **SLEEP MODE** : Press the SLEEP button to turn on the sleep mode
8. **SWING** : Press this button to control the swing function.

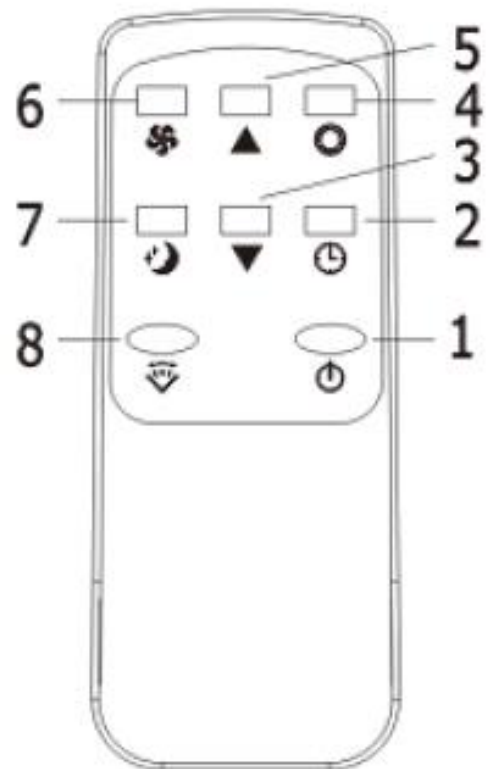

## MULTI PROTECTIVE FUNCTIONS

### ANTI-FREEZING PROTECTING CONTROL

When the ambient temperature is low while in Cooling Mode, the compressor and water motor will stop working. If the copper coil temperature reaches  $< 2^{\circ}\text{C}$  for over 20 seconds. When the copper coil temperature increases to  $> 8^{\circ}\text{C}$ , the protection will be stopped.

### WATER-FULL PROTECTION:

When the water level in the internal water tank is surpassing the maximum level, the unit will sound an alarm and the water full light will illuminate. Please discharge water from the tank within the machine.

### COMPRESSOR DELAY-PROTECTION

The compressor runs a 3 minute delay protection function.

### COMPRESSOR PROTECTION

In cooling and dehumidifying modes, if the temperature difference between the coil temperature and room temperature is less than  $3^{\circ}\text{C}$ , for more than 30 minutes, the machine will enter the 'no refrigerant' compressor protection mode. The compressor and water spring motor will stop working. The up fan runs at low speed and the down fan stops running

# EMPTYING THE INTERNAL WATER TANK

## MANUAL DRAINAGE:

When the internal water tank is full the unit will stop working. Shut off the unit and unplug. Try not to move the model abruptly as this may cause the water in the internal tank to spill out.

Place a tray under the water plug or place the unit in a drainage area.

Unscrew the drain plug cap and remove the rubber stopper - water will drain from the internal tank.

Put the rubber stopper back and screw the drain plug cap back into place.

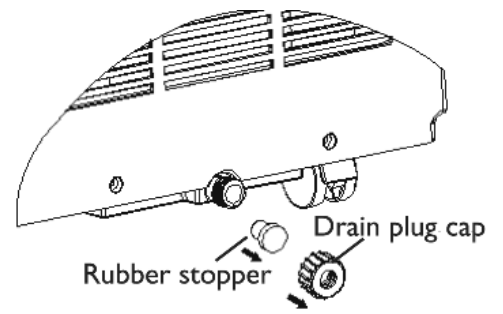

## CONTINUOUS DRAINAGE:

Unscrew the drain plug cap and remove the rubber stopper.

Connect a water pipe to the water outlet.

You can plumb this pipe into your current plumbing system, lead it outside and use gravity fall or use a water pump.

**Note:** This model has a self-evaporative function, which reduces the need to empty the water tank. If the unit is vented correctly most of the water is reused to cool the condenser coils and any excess is evaporated. Please do not use continuous drainage if you intend to use the self-evaporating facility.

# MAINTENANCE

## CLEANING

**PLEASE SHUT OFF THE UNIT AND UNPLUG FROM THE MAINS BEFORE CLEANING OR PERFORMING ANY MAINTENANCE**

### CLEAN THE SURFACE

Clean the surface of the machine with a wet soft cloth. Do not use chemicals, such as benzene, alcohol, gasoline, etc; otherwise, as this may cause damage to the surface and or the internal workings of the machine

### AIR FILTER CLEANING

If the filter screen is clogged with dust, the effectiveness of the air conditioner is reduced. The filter screen should be cleaned once every two weeks or as often as necessarily in your environment.

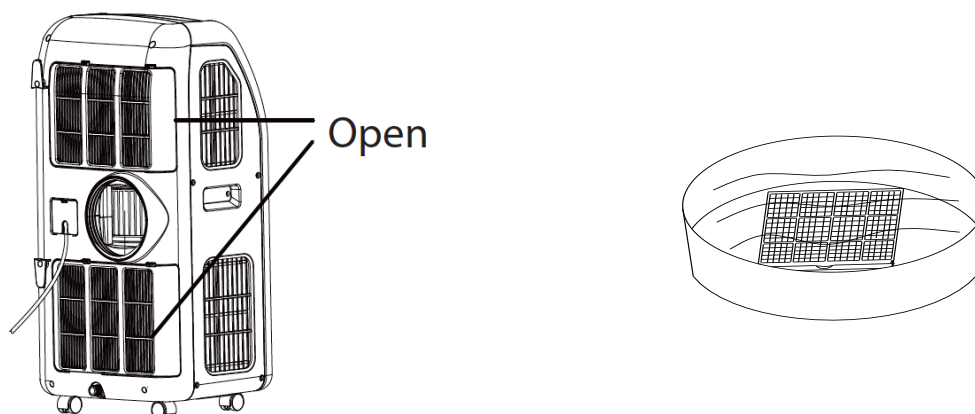

### CLEAN THE UPPER FILTER SCREEN FRAME

Grip the edge of the evaporator filter screen frame with both hands. Pull out to remove the filter screen from its frame. If present, unscrew the screws fixing the filter before removing it (as shown in the above figure).

Put the evaporator filter screen into warm water with neutral detergent (about 40°C /104°F) and dry it in the shade after rinsing clean.

### CLEAN THE LOWER FILTER SCREEN FRAME

Hold the handle of the air inlet filter screen frame, and pull it outward gently to remove it.

Put the filter screen into warm water with neutral detergent (about 40°C / 104 °F) and dry it in the shade after rinsing clean.

## END OF SEASON MAINTENANCE

1. Remove the rubber stopper and drain plug cap from the drainage hole and empty the internal tank. You can also drain the water by leaning the unit.
  2. Then switch the unit to low fan mode.
  3. Keep the unit in this mode for half day - until the conduit is dried. Doing this helps to keep the inside of the unit dry and prevents mould from developing
  4. Turn off the unit and pull out the plug.
  5. Replace the rubber stopper and drain plug cap
  6. Coil the wire and bind it together, then put it into the accessories space.
  7. Separate the air-exhaust pipe and store it safely.
  8. Cover the unit and keep it in a dry place.
  9. Take the batteries out of remote control and store or dispose of them safely
- Keep all accessories with the unit ready for next season.

## TROUBLESHOOTING

Do not repair or disassemble the air conditioning. Unqualified repair will invalidate the warranty and may lead to failure, causing injuries and property damage. Only use it as directed in this user manual and only perform operations advised here.

Problems	Reasons	Solutions
The air conditioner does not work.	There is no electricity.	Turn it on after connecting it to a socket with electricity.
	The overflow indicator displays "FL".	Discharge the water inside.
	The ambient temperature is too low or too high	Only use to use the machine within temperature range of 7-35°C (44-95°F).
	In cooling mode, the room temperature is lower than the set temperature; in heating mode, the room temperature is higher than the set temperature.	Change the set temperature.
	In dehumidification mode, the ambient temperature is low.	The machine is placed in a room with an ambient temperature of greater than 17 °C. (62 °F).
The cooling effect is not good	There is direct sunlight.	Use curtains to reduce the direct sun heat
	Doors or windows are open; there are a lot of people; or in cooling mode, there are other sources of heat (e.g. fridges)	Close doors and windows; increase air conditioning power
	The filter screen is dirty.	Clean or replace the filter screen.
	The air inlet or outlet is blocked.	Clear obstructions; make sure venting is correct as described in this user manual and hose is not bent
Loud Noise	The air conditioning is not placed on a flat surface.	Put the air conditioning on a flat and hard place (to reduce noise).
Compressor does not work.	Overheat protection starts.	Wait for 3 minutes until the temperature is lowered, and then restart the machine.
The remote control does not work.	The distance between the machine and the remote control is too far.	Let the remote control get close to the air conditioning, and make sure that the remote control directly faces to the direction of the remote-control receiver.
	The remote control is not aligned with the direction of the remote control receiver.	
	Batteries are dead.	Replace batteries.
Displays 'E1'.	The pipe temperature sensor is abnormal.	Clean filters and restart. Refer to service centre if issue still persist.
Displays 'E2'	The room temperature sensor is abnormal.	Clean filters and restart. Refer to service centre if issue still persist.
Main LED light flashing	Water tank is full inside the machine	Drain out water from drain port at bottom rear of the unit.
Others	No refrigerant or there is very little refrigerant	Refer to Service Centre (check leakage, welding, vacuum pump, charge refrigerant according to name plate)
	Anti-freezing protection	Waiting for defrosting. Function will recover automatically. No user input needed.
	High pressure protection	After inside gas pressure comes down, it will function normally. No user input needed

If problems not listed in the table occur or recommended solutions do not work, please contact the service centre.

## APPENDIX



Disposal: Do not dispose this product as unsorted municipal waste. Collection of such waste must be handled separately as special treatment is necessary. Recycling facilities are now available for all customers at which you can deposit your old electrical products. Customers will be able to take any old electrical equipment to participating civic amenity sites run by their local councils. Please remember that this equipment will be further handled during the recycling process, so please be considerate when depositing your equipment. Please contact the local council for details of your local household waste recycling centres.

## TECHNICAL DATA

MODEL	SILENT10-V2
Capacity Cooling	2.63kWh, 9,000BTU
Rated Input	1.01kW
Running Current	4.4A
Air Flow	380m <sup>3</sup> /h
EER rate	A
Compressor	Rotary, R290 gas
Noise	38-48dB(A) Sound Energy <65dB(A) Sound Power
Thermostat	16-31°C
Moisture removal	24 L/Day
Permitted Excessive Operating Pressure	0.6/1.8MPa
Maximum Allowable Pressure	3.0Mpa
Power Supply	220-240V/50Hz
Net Weight	23.5kg
Dimension(L*D*H)	350*350*756mm
<p>Unit must be vented outside when in Air Cooling and Heating mode. For the purposes of EU regulation EN12102 this is a local air conditioner and produces less than 65dB(A) sound energy.</p> <div style="text-align: center;">   <b>R290</b> </div>	

## **electriQ UK SUPPORT**

[www.electriQ.co.uk/support](http://www.electriQ.co.uk/support)

Please, for your own convenience, make these simple checks before calling the service line. If the unit still fails to operate call the number below, or complete the online form.

0871 620 1057

1. Has the unit been standing upright for at least 2 hours?
2. Is the unit plugged into the mains?
3. Is the fuse OK?
4. Switch the unit off and wait three minutes to see if the issue is resolved. Restart the unit.
5. Check if the water tank is full.

Office hours: 9AM - 5PM Monday to Friday

[www.electriQ.co.uk](http://www.electriQ.co.uk)  
Unit J6, Lowfields Business Park  
Lowfields Way, Elland  
West Yorkshire, HX5 9DA